

RUIDONG

AIR COOLED MODULAR
WATER CHILLER & HEAT
PUMP



RUIDONG GROUP

www.ruidonggroup.com



Ruidong Group Co., Ltd is one modern large-scale enterprise integrating design, production, sales and installation of central air-conditioning products.

Ruidong is located in Dezhou City, Shandong Province. The Beijing-Shanghai High-speed Railway and Beijing-Shanghai Expressway passing through the city, make Dezhou become a key coordinate of the national economic artery. The registered capital of the group is one hundred fifty five and a half million yuan, covering an area of 300,000 square meters and construction area of 180,000 square meters.

Main business coverage:

1. Host series:

- Water cooled series: centrifugal cold (hot) water unit, screw type cold water unit, screw type water (ground) source cooling and heating unit, scroll type water (ground) source cooling and heating unit.
- Air cooled series: screw type cold (hot) water unit, modular type cold (hot) water unit, mini type cold (hot) water unit, VRV series unit.
- Packaged Unitary unit: constant temperature and humidity unit, air (water) cooled unitary unit, dehumidification unit.

2. Direct expansion series: Rooftop packaged unit, ducted split unit.

3. Terminal series: Purification air handling unit, combined air handling unit, fresh air unit, fan coil unit series.



ENTERPRISE PROFILE

4. **Ventilation series:** Fire exhaust fan, roof fan, axial fan, diagonal fan, centrifugal fan, etc.
5. **Engine room equipment:** cyclone sand remover, water separator (separator), decontamination device, demineralized water device, plate heat exchange unit, constant pressure equipment, etc.
6. **Air conditioning accessories:** All kinds of fire valves, regulating valves, tuyere series.
7. **Other products:** Low-temperature industrial chillers, air-conditioning equipment for planting and breeding industries.

The R & D team composed of high-tech talents will continue to introduce new products, advanced production equipment and adopt the international ISO9001 quality management system as a strong guarantee for product quality. Precision testing equipment and rigorous testing methods are the fundamental insurance of quality and are timely and thoughtful. After-sales service solves the problems that may arise in use for you.

The company has established a complete sales and service system. Set up offices in 18 cities including Beijing, Tianjin, Shanghai, Xi'an, Shenyang, Chengdu and other cities to provide users with timely, efficient and high-quality pre-sales, sales and after-sales services.

Ruidong Air Conditioning wishes you: Cooling air for propitious summer, spring returns with warm air from Ruidong.

CERTIFICATIONS

Ruidong group always takes "create first-class quality, offer sincere service" as the quality concept, builds customer-oriented quality management system, focuses on teamwork and insists on continuous innovation.



CONTENTS

1. Naming Scheme	P04
2. Brief Introduction	P04
3. Structure Diagram	P06
4. Specification	P08
5. Connection & Base	P16
6. Correction Factor	P22

1. NAMING SCHEME

RLS F W M XXX R Z H X D HR

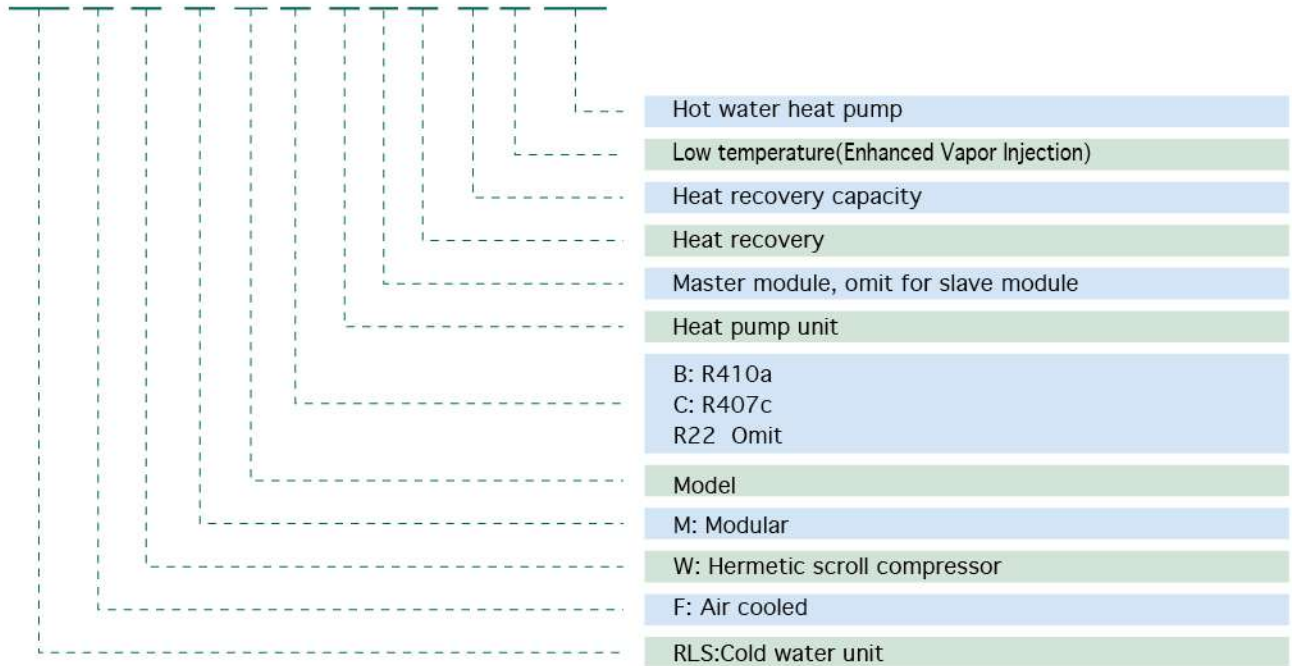

2. BRIEF INTRODUCTIO

1. Modular Type Air Cooled Water Chiller And Heat pump

Applicable places:

Suitable for new construction and renovation projects. It can be installed on the roof or outdoor courtyard. It does not allow special computer rooms and cooling towers. It is widely used in hotels, hospitals, theaters, gymnasiums, entertainment centers, commercial buildings, office buildings, and working conditions.

Features:

a. Easy to install and save space: no need for auxiliary equipment such as cooling water pumps and cooling towers, which can save a lot of materials and engineering installation costs. The freezer room can save investors valuable building space.

b. One machine for two purposes: heating and cooling can be achieved, and heating and cooling can be achieved through a set of systems.

c. Modular system design: make each refrigeration system independent and spare each other. An abnormal situation in any refrigeration loop will not affect the normal operation of other loops; the unit is produced and transported with standard modular units, and assembled into a complete unit at the installation site. The standard modular unit is light in weight and small in size, which can save transportation And the cost of hoisting; free combination between modules can be carried out according to user requirements and the size of the air-conditioning area; when the unit is started, the computer-controlled compressors are started in sequence, reducing the impact on the grid current.

d. Excellent performance, safe and reliable.



Configuration

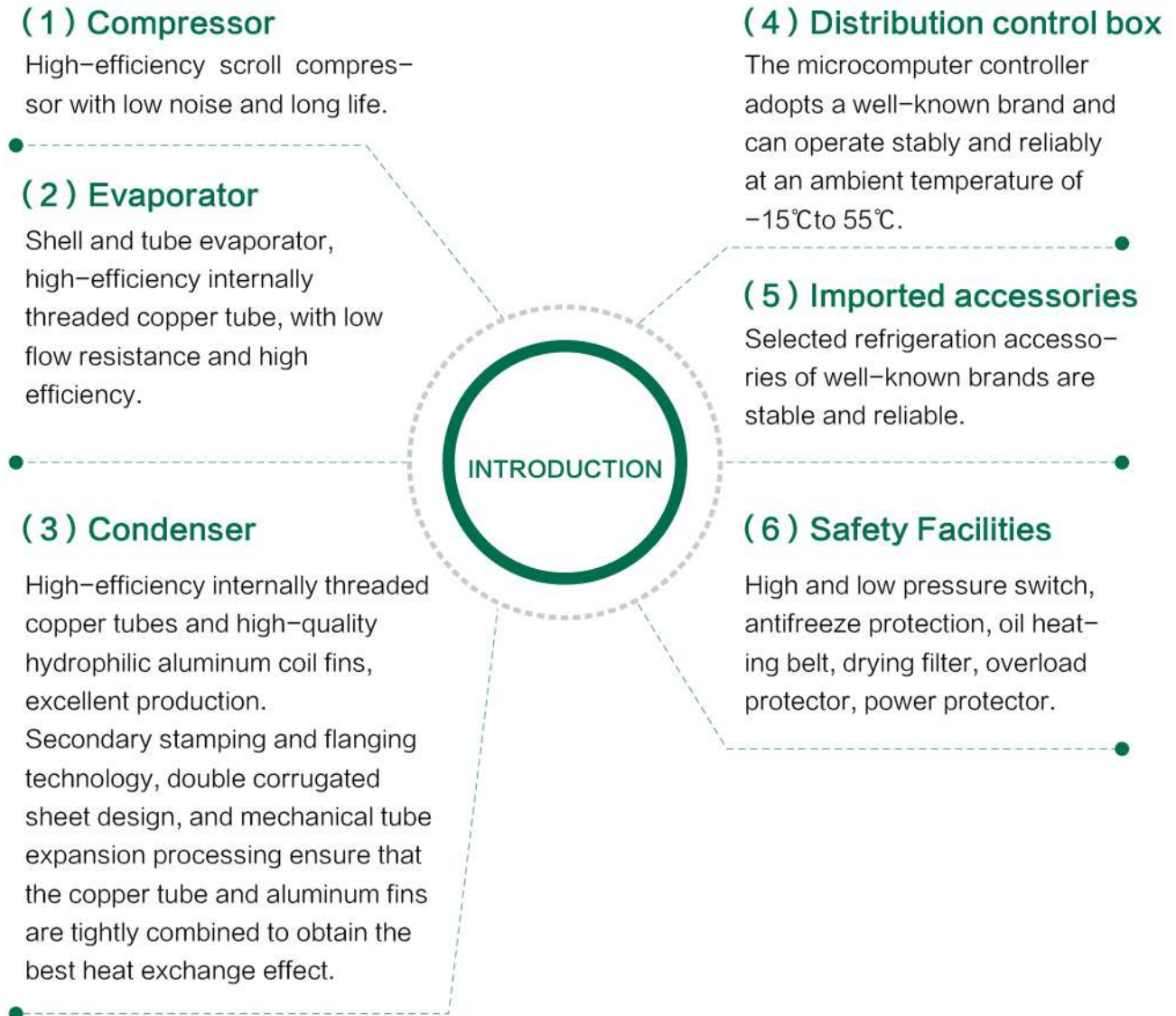

2. Heat Recovery Type Modular Type Air Cooled Water Chiller And Heat pump (non-standard unit, please indicate when ordering)

a> Heat recovery unit is one unit that integrates two or three functions of refrigeration, heating and making domestic hot water. There are two types of heat recovery: 30% recovery and 100% recovery.

b> The cooling only unit can recover the originally discarded condensing heat while cooling in summer, and can also be cooled separately; the heat pump unit has three functions of cooling, heating and making domestic hot water.

c> The comprehensive performance coefficient of the heat recovery unit is as high as 3.5 ~ 3.9. The addition of the heat recovery unit is equivalent to increasing the heat exchange area of the unit and enhancing the heat exchange effect, thereby reducing the energy consumption of the unit.

3. Low Temperature Modular Type Air Cooled Water Chiller And Heat pump (non-standard unit, please specify when ordering)

Adopting EVI scroll compressor and economizer, the unit can be used normally in low temperature environment, and greatly improve the heating operation efficiency of the unit in winter.

a> The compressor has added one gas filling port, the suction air of the unit is increased, the circulation flow is increased, the heat exchange heat of the unit on the condensing side is greatly increased, the heating capacity of the unit is increased by more than 30%, and the performance coefficient Also greatly improved.

b> By optimizing the matching of products, the amount of refrigerant evaporated in the evaporator at low ambient temperature is increased, which can effectively avoid the failure of the refrigerant to completely evaporate due to the poor evaporation effect and the return of the compressor.

c> Increase the enthalpy of the compressor by supplementing the air, increasing the displacement of the compressor, ensuring that the product still runs stably at low ambient temperature, the compressor will not exceed the compression ratio of the compressor, ensuring the safe performance of the compressor Reduce the compressor discharge temperature and extend the life of the compressor.

3. STRUCTURE DIAGRAM

RLSFWM68/RLSFWM75

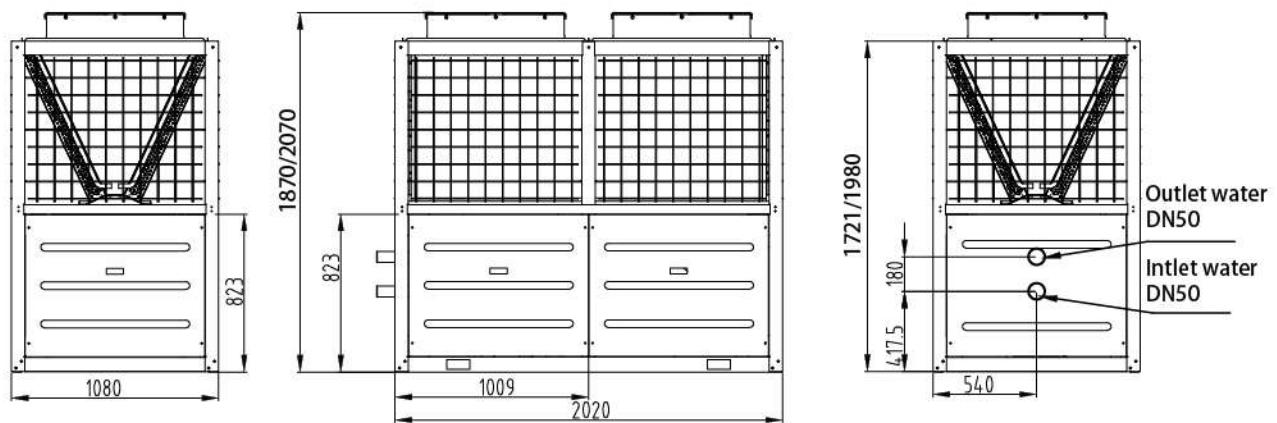

RLSFWM136

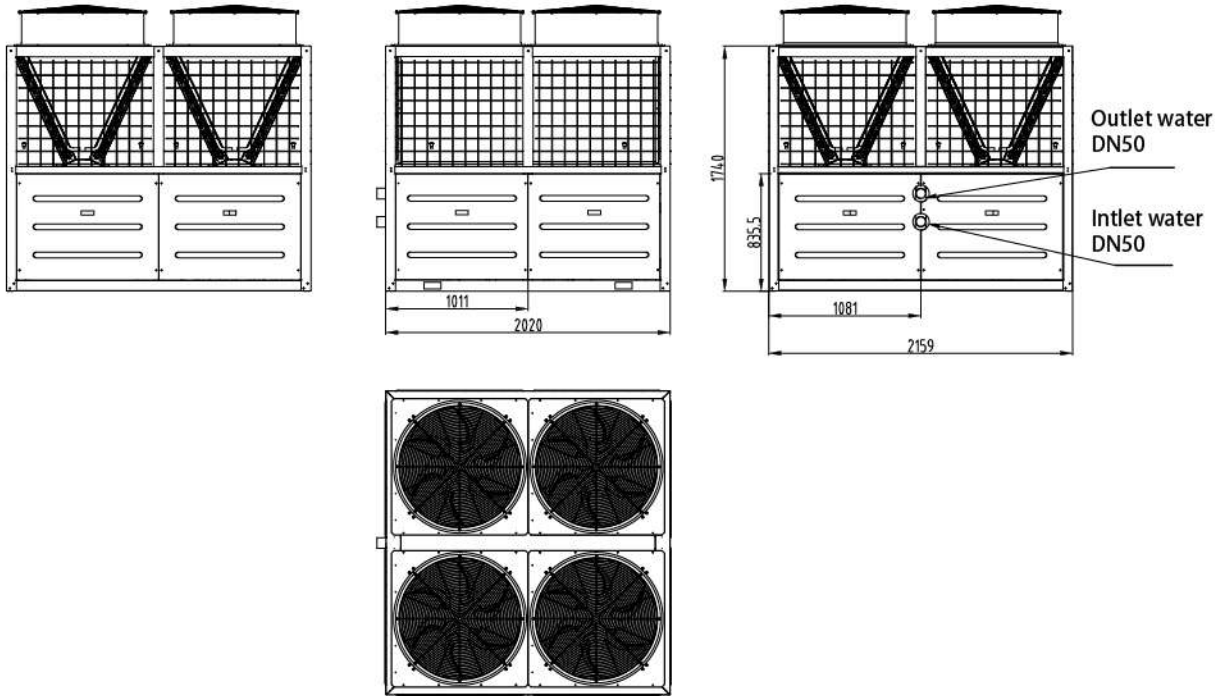

RLSFWM150

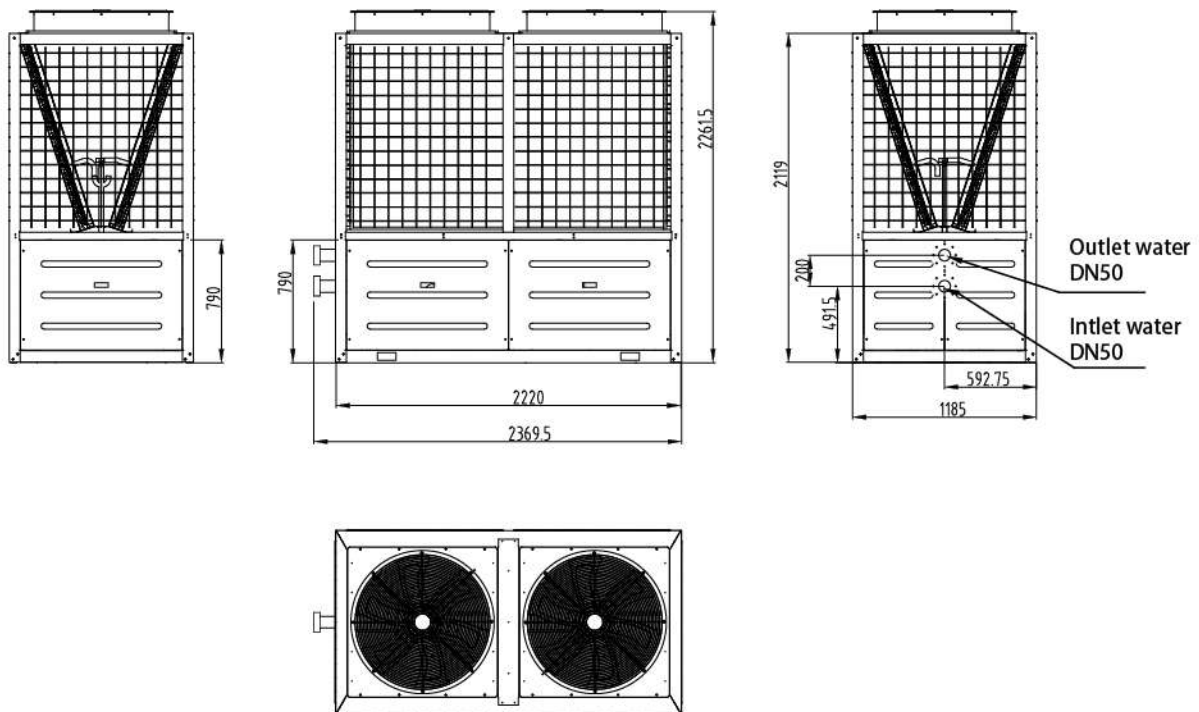

4.SPECIFICATION

Modular type air cooled water chiller and heat pump(1)

Unit model	RLSFWM-(B) RLSWFM-(B)R	68	136	204	272	340	408	476
Nominal cooling capacity	kW	68	136	204	272	340	408	476
Input power	kW	21.1	42.2	63.2	84.3	105.4	126.5	147.6
Running current	A	41.2	82.4	123.6	164.8	206.0	247.2	288.4
Nominal heating capacity	kW	70	140	210	280	350	420	490
Input power	kW	22.1	44.1	66.2	88.2	110.3	132.4	154.4
Running current	A	39.5	79.0	118.5	158.0	197.5	237.0	276.5
Max.running current	A	48.2	96.4	144.6	192.8	241	289.2	337.4
Cable diameter (copper wire distance ≤ 20 meters)	mm ²	3*16+2*10	(3*16+2*10)*2	(3*16+2*10)*3	(3*16+2*10)*4	(3*16+2*10)*5	(3*16+2*10)*6	(3*16+2*10)*7
Compressor type	Hermetic scroll							
Compressor qty		2	4	6	8	10	12	14
Power voltage	3N-380V-50HZ							
Starting mode	Direct							
Refrigerant	R410A/R22							
Refrigerant charge		11.5*2	11.5*4	11.5*6	11.5*8	11.5*10	11.5*12	11.5*14
Refrigerant control device	Electronic expansion valve(EXV)							
Evaporator	Type	Shell & tube type						
	Water pressure drop	kPa	70					
	Water pipe Dia.DN	50	50*2	50*3	50*4	50*5	50*6	50*7
	Water flow	m ³ /h	11.7	23.4	35.1	46.8	58.5	70.2
Condenser type	Internally threaded copper tube & hydrophilic aluminum fins							
Protection device	High and low voltage protection, antifreeze protection, temperature control, reverse phase and phase loss protection, high and low voltage protection, high pressure exhaust temperature protection, built-in motor overheat protection, overcurrent protection, check valve, safety valve							
Dimensions	L	2110	2110	2110	2110	2110	2110	2110
	W	1080	2160	3240	4320	5400	6480	7560
	H	1870	1870	1870	1870	1870	1870	1870
Net weight	kg	700	1400	2100	2800	3500	4200	4900
Running weight	kg	760	1520	2280	3040	3800	4560	5320
Noise	dB(A)	73	73	73	74	74	74	74

Remarks:

- 1.Cooling standard working conditions: ambient temperature 35 °CDB / 24 °C WB; cold water inlet temperature 12 °C, outlet temperature 7 °C.
- 2.Heating standard working conditions: ambient temperature 7 °C DB / 6 °C WB; hot water inlet temperature 40 °C, outlet temperature 45 °C.

Modular type air cooled water chiller and heat pump(2)

Unit model	RLSFWM-(B) RLSWFM-(B)R	136	272	408	544	680	816	952
Nominal cooling capacity	kW	136	272	408	544	680	816	952
Input power	kW	42.2	84.3	126.5	168.6	210.8	253.0	295.1
Running current	A	80.4	162.8	241.2	321.6	402.0	482.4	562.8
Nominal heating capacity	kW	140	280	420	560	700	840	980
Input power	kW	44.1	88.2	132.4	176.5	220.6	264.7	308.8
Running current	A	76.4	150.8	229.2	305.6	382.0	458.4	534.8
Max.running current	A	96.4	195.3	289.2	385.6	482.0	578.4	674.8
Cable diameter (copper wire distance ≤ 20 meters)	mm ²	3*35+2*16	(3*35+2*16)*2	(3*35+2*16)*3	(3*35+2*16)*4	(3*35+2*16)*5	(3*35+2*16)*6	(3*35+2*16)*7
Compressor type	Hermetic scroll							
Compressor qty		4	8	12	16	20	24	28
Power voltage	3N-380V-50HZ							
Starting mode	Direct							
Refrigerant	R410A/R22							
Refrigerant charge		11.5*4	11.5*8	11.5*12	11.5*16	11.5*20	11.5*24	11.5*28
Refrigerant control device	Electronic expansion valve(EXV)							
Evaporator	Type	Shell & tube type						
	Water pressure drop	kPa	70					
	Water pipe Dia.DN	65	65*2	65*3	65*4	65*5	65*6	65*7
	Water flow	m ³ /h	23.4	46.8	70.2	93.6	117.0	140.4
Condenser type	Internally threaded copper tube & hydrophilic aluminum fins							
Protection device	High and low voltage protection, antifreeze protection, temperature control, reverse phase and phase loss protection, high and low voltage protection, high pressure exhaust temperature protection, built-in motor overheat protection, overcurrent protection, check valve, safety valve							
Dimensions	L	2110	2110	2110	2110	2110	2110	2110
	W	2160	4320	6480	8640	10800	12960	15120
	H	1870	1870	1870	1870	1870	1870	1870
Net weight	kg	1360	2720	4080	5440	6800	8160	9520
Running weight	kg	1480	2960	4440	5920	7400	8880	10360
Noise	dB(A)	73	73	73	74	74	74	74

Remarks:

- 1.Cooling standard working conditions: ambient temperature 35 °CDB / 24 °C WB; cold water inlet temperature 12 °C, outlet temperature 7 °C.
- 2.Heating standard working conditions: ambient temperature 7 °C DB / 6 °C WB; hot water inlet temperature 40 °C, outlet temperature 45 °C.

Modular type air cooled water chiller and heat pump(3)

Unit model	RLSFWM-(B) RLSWFM-(B)R	75	150	225	300	375	450	525	
Nominal cooling capacity	kW	71	142	213	284	355	426	497	
Input power	kW	20.6	41.2	61.8	82.4	103	123.6	144.2	
Running current	A	44	88	132	176	220	264	308	
Nominal heating capacity	kW	72	144	216	288	360	432	504	
Input power	kW	20.3	40.5	60.8	81.0	101.3	121.5	141.8	
Running current	A	43	86	129	172	215	258	301	
Max.running current	A	61.2	122.4	183.6	244.8	306	367.2	428.4	
Cable diameter (copper wire distance ≤ 20 meters)	mm ²	3*25+2*16	(3*25+2*16) *2	(3*25+2*16) *3	(3*25+2*16) *4	(3*25+2*16) *5	(3*25+2*16) *6	(3*25+2*16) *7	
Compressor type	Hermetic scroll								
Compressor qty		1	2	3	4	5	6	7	
Power voltage	3N-380V-50HZ								
Starting mode	Direct								
Refrigerant	R410A/R22								
Refrigerant charge		13.5	13.5*2	13.5*3	13.5*4	13.5*5	13.5*6	13.5*7	
Refrigerant control device	Electronic expansion valve(EXV)								
Evaporator	Type	Shell & tube type							
	Water pressure drop	kPa	70						
	Water pipe Dia.DN		50	50*2	50*3	50*4	50*5	50*6	50*7
	Water flow	m ³ / h	12.2	24.4	36.6	48.8	61.1	73.3	85.5
Condenser type	Internally threaded copper tube & hydrophilic aluminum fins								
Protection device	High and low voltage protection, antifreeze protection, temperature control, reverse phase and phase loss protection, high and low voltage protection, high pressure exhaust temperature protection, built-in motor overheat protection, overcurrent protection,check valve, safety valve								
Dimensions	L	2110	2110	2110	2110	2110	2110	2110	
	W	1080	2160	3240	4320	5400	6480	7560	
	H	2070	2070	2070	2070	2070	2270	2070	
Net weight	kg	660	980	1320	1960	1980	2940	2640	
Running weight	kg	690	1040	1380	2080	2070	3120	2760	
Noise	dB(A)	74	74	74	74	74	75	75	

Remarks:

- 1.Cooling standard working conditions: ambient temperature 35 °CDB / 24 °C WB; cold water inlet temperature 12 °C, outlet temperature 7 °C.
- 2.Heating standard working conditions: ambient temperature 7 °C DB / 6 °C WB; hot water inlet temperature 40 °C, outlet temperature 45 °C.

Modular type air cooled water chiller and heat pump(4)

Unit model	RLSFWM-(B) RLSWFM-(B)R	150	300	450	600	750	900	1050
Nominal cooling capacity	kW	142	284	426	568	710	852	994
Input power	kW	41.2	82.4	123.6	164.8	206	247.2	288.4
Running current	A	88	176	264	352	440	528	616
Nominal heating capacity	kW	144	288	432	576	720	864	1008
Input power	kW	40.5	81	121.5	162	202.5	243	283.5
Running current	A	86	172	258	344	430	516	602
Max.running current	A	122.4	244.8	367.2	489.6	612	734.4	856.8
Cable diameter (copper wire distance ≤ 20 meters)	mm ²	3*35+2*16	(3*35+2*16)*2	(3*35+2*16)*3	(3*35+2*16)*4	(3*35+2*16)*5	(3*35+2*16)*6	(3*35+2*16)*7
Compressor type	Hermetic scroll							
Compressor qty		2	4	6	8	10	12	14
Power voltage	3N-380V-50HZ							
Starting mode	Direct							
Refrigerant	R410A/R22							
Refrigerant charge		13.5*2	13.5*4	13.5*6	13.5*8	13.5*10	13.5*12	13.5*14
Refrigerant control device	Electronic expansion valve(EXV)							
Evaporator	Type	Shell & tube type						
	Water pressure drop	kPa	70					
	Water pipe Dia.DN	65	65*2	65*3	65*4	65*5	65*6	65*7
	Water flow	m ³ /h	24.42	48.85	73.27	97.70	122.12	146.54
Condenser type	Internally threaded copper tube & hydrophilic aluminum fins							
Protection device	High and low voltage protection, antifreeze protection, temperature control, reverse phase and phase loss protection, high and low voltage protection, high pressure exhaust temperature protection, built-in motor overheat protection, overcurrent protection, check valve, safety valve							
Dimensions	L	2370	2370	2370	2370	2370	2370	2370
	W	1185	2370	3555	4740	5925	7110	8295
	H	2260	2260	2260	2260	2260	2260	2260
Net weight	kg	980	1960	2940	3920	4900	5880	6860
Running weight	kg	1180	2360	3540	4720	5900	7080	8260
Noise	dB(A)	74	74	74	74	74	75	75

Remarks:

1. Cooling standard working conditions: ambient temperature 35 °CDB / 24 °C WB; cold water inlet temperature 12 °C, outlet temperature 7 °C.
2. Heating standard working conditions: ambient temperature 7 °C DB / 6 °C WB; hot water inlet temperature 40 °C, outlet temperature 45 °C.

EVI type air cooled water chiller and heat pump(1)

Unit model		RLSFWM-BRD	68	136	204	272	340	408	476
		RLSFWM-RD							
Nominal cooling capacity	kW		68	136	204	272	340	408	476
Input power	kW		21.1	42.2	63.2	84.3	105.4	126.5	147.6
Running current	A		41.2	82.4	123.6	164.8	206.0	247.2	288.4
Nominal heating capacity ¹	kW		78	156	234	312	390	468	546
Input power	kW		22.3	44.7	67.0	89.4	111.7	134.0	156.4
Running current	A		41.6	79	118.5	158	197.5	237	276.5
Nominal heating capacity ¹	kW		57	114	171	228	285	342	399
Input power	kW		21.3	42.6	63.9	85.2	106.5	127.8	149.1
Running current	A		41.6	83.2	124.8	166.4	208.0	249.6	291.2
Max.running current	A		50.4	96.4	144.6	192.8	241	289.2	337.4
Cable diameter (copper wire distance ≤ 20 meters)	mm ²		3*16+2*10	(3*16+2*10)*2	(3*16+2*10)*3	(3*16+2*10)*4	(3*16+2*10)*5	(3*16+2*10)*6	(3*16+2*10)*7
Compressor type	Hermetic scroll								
Compressor qty			2	4	6	8	10	12	14
Power voltage	3N-380V-50HZ								
Starting mode	Starting mode								
Refrigerant	R410A/R22								
Refrigerant charge			11 × 2	11 × 4	11 × 6	11 × 8	11 × 10	11 × 12	11 × 14
Refrigerant control device	Electronic expansion valve(EXV)								
Evaporator	Type		Shell & tube type						
	Water pressure drop	kPa	70						
	Water pipe Dia.DN		50	50*2	50*3	50*4	50*5	50*6	50*7
	Water flow	m ³ /h	10.66	21.32	31.98	42.64	53.30	63.96	74.62
Condenser type	Internally threaded copper tube & hydrophilic aluminum fins								
Protection device	High and low voltage protection, antifreeze protection, temperature control, reverse phase and phase loss protection, high and low voltage protection, high pressure exhaust temperature protection, built-in motor overheat protection, overcurrent protection,check valve, safety valve								
Dimensions	L		2110	2110	2110	2110	2110	2110	2110
	W		1080	2160	3240	4320	5400	6480	7560
	H		1870	1870	1870	1870	1870	1870	1870
Net weight	kg		700	1400	2100	2800	3500	4200	4900
Running weight	kg		760	1520	2280	3040	3800	4560	5320
Noise	dB(A)		73	73	73	74	74	74	74

Remarks:

- 1.Cooling standard working conditions: ambient temperature 35 °CDB / 24 °C WB; cold water inlet temperature 12 °C, outlet temperature 7 °C.
- 2.Heating standard working conditions: ambient temperature 7 °C DB / 6 °C WB; hot water inlet temperature 40 °C, outlet temperature 45 °C.

EVI type air cooled water chiller and heat pump(2)

Unit model		RLSFWM-BRD	136	272	408	544	680	816	952
		RLSFWM-RD							
Nominal cooling capacity	kW		136	272	408	544	680	816	952
Input power	kW		42.2	84.4	126.6	168.8	211	253.2	295.4
Running current	A		82.4	164.8	247.2	329.6	412	494.4	576.8
Nominal heating capacity ¹	kW		156	312	468	624	780	936	1092
Input power	kW		44.7	89.4	134.0	178.7	223.4	268.1	312.8
Running current	A		80.4	160.8	241.2	321.6	402	482.4	562.8
Nominal heating capacity ¹¹	kW		114	228	342	456	570	684	798
Input power	kW		42.6	85.2	127.8	170.4	213.0	255.6	298.2
Running current	A		83.2	166.4	249.6	332.8	416.0	499.2	582.4
Max.running current	A		96.4	192.8	289.2	385.6	482	578.4	674.8
Cable diameter (copper wire distance ≤ 20 meters)	mm ²		3*35+2*16	(3*35+2*16)*2	(3*35+2*16)*3	(3*35+2*16)*4	(3*35+2*16)*5	(3*35+2*16)*6	(3*35+2*16)*7
Compressor type	Hermetic scroll								
Compressor qty			4	8	12	16	20	24	28
Power voltage	3N-380V-50HZ								
Starting mode	Starting mode								
Refrigerant	R410A/R22								
Refrigerant charge			11.5*4	11.5*8	11.5*12	11.5*16	11.5*20	11.5*24	11.5*28
Refrigerant control device	Electronic expansion valve(EXV)								
Evaporator	Type		Shell & tube type						
	Water pressure drop	kPa	70						
	Water pipe Dia.DN		65	65*2	65*3	65*4	65*5	65*6	65*7
	Water flow	m ³ /h	23.39	46.78	70.18	93.57	116.96	140.35	163.74
Condenser type	Internally threaded copper tube & hydrophilic aluminum fins								
Protection device	High and low voltage protection, antifreeze protection, temperature control, reverse phase and phase loss protection, high and low voltage protection, high pressure exhaust temperature protection, built-in motor overheat protection, overcurrent protection,check valve, safety valve								
Dimensions	L		2110	2110	2110	2110	2110	2110	2110
	W		2160	4320	6480	8640	10800	12960	15120
	H		1870	1870	1870	1870	1870	1870	1870
Net weight	kg		1360	2720	4080	5440	6800	8160	9520
Running weight	kg		1480	2960	4440	5920	7400	8880	10360
Noise	dB(A)		73	73	73	74	74	74	74

Remarks:

- 1.Cooling standard working conditions: ambient temperature 35 °CDB / 24 °C WB; cold water inlet temperature 12 °C, outlet temperature 7 °C.
- 2.Heating standard working conditions: ambient temperature 7 °C DB / 6 °C WB; hot water inlet temperature 40 °C, outlet temperature 45 °C.

EVI type air cooled water chiller and heat pump(3)

Unit model		RLSFWM-BRD	75	150	225	300	375	450	525
		RLSFWM-RD							
Nominal cooling capacity	kW		70	140	210	280	350	420	490
Input power	kW		22.8	45.6	68.4	91.2	114	136.8	159.6
Running current	A		44	88	132	176	220	264	308
Nominal heating capacity	kW		85	170	255	340	425	510	595
Input power	kW		22.5	45	67.5	90	112.5	135	157.5
Running current	A		43	86	129	172	215	258	301
Nominal heating capacity	kW		62	124	186	248	310	372	434
Input power	kW		24.8	49.6	74.4	99.2	124.0	148.8	173.6
Running current	A		47.8	95.6	143.4	191.2	239.0	286.8	334.6
Max. running current	A		61.2	122.4	183.6	244.8	306	367.2	428.4
Cable diameter (copper wire distance ≤ 20 meters)	mm ²		3*16+2*10	(3*16+2*10)*2	(3*16+2*10)*3	(3*16+2*10)*4	(3*16+2*10)*5	(3*16+2*10)*6	(3*16+2*10)*7
Compressor type	Hermetic scroll								
Compressor qty			1	2	3	4	5	6	7
Power voltage	3N-380V-50HZ								
Starting mode	Starting mode								
Refrigerant	R410A/R22								
Refrigerant charge			13.5	13.5*2	13.5*3	13.5*4	13.5*5	13.5*6	13.5*7
Refrigerant control device	Electronic expansion valve(EXV)								
Evaporator	Type		Shell & tube type						
	Water pressure drop	kPa	70						
	Water pipe Dia. DN		50	50*2	50*3	50*4	50*5	50*6	50*7
	Water flow	m ³ /h	12.0	24.1	36.1	48.2	60.2	72.2	84.3
Condenser type	Internally threaded copper tube & hydrophilic aluminum fins								
Protection device	High and low voltage protection, antifreeze protection, temperature control, reverse phase and phase loss protection, high and low voltage protection, high pressure exhaust temperature protection, built-in motor overheat protection, overcurrent protection, check valve, safety valve								
Dimensions	L		2110	2110	2110	2110	2110	2110	2110
	W		1080	2160	3240	4320	5400	6480	7560
	H		2070	2070	2070	2070	2070	2270	2070
Net weight	kg		660	980	1320	1960	1980	2940	2640
Running weight	kg		690	1040	1380	2080	2070	3120	2760
Noise	dB(A)		74	74	74	74	74	75	75

Remarks:

1. Cooling standard working conditions: ambient temperature 35 °C DB / 24 °C WB; cold water inlet temperature 12 °C, outlet temperature 7 °C.
2. Heating standard working conditions: ambient temperature 7 °C DB / 6 °C WB; hot water inlet temperature 40 °C, outlet temperature 45 °C.

EVI type air cooled water chiller and heat pump(4)

Unit model		RLSFWM-BRD	150	300	450	600	750	900	1050
		RLSFWM-RD							
Nominal cooling capacity	kW		140	280	420	560	700	840	980
Input power	kW		45.6	91.2	136.8	182.4	228	273.6	319.2
Running current	A		88	176	264	352	440	528	616
Nominal heating capacity ¹	kW		170	340	510	680	850	1020	1190
Input power	kW		45	90	135	180	225	270	315
Running current	A		86	172	258	344	430	516	602
Nominal heating capacity ¹	kW		124	248	372	496	620	744	868
Input power	kW		49.6	99.2	148.8	198.4	248.0	297.6	347.2
Running current	A		95.6	191.2	286.8	382.4	478.0	573.6	669.2
Max.running current	A		122.4	244.8	367.2	489.6	612	734.4	856.8
Cable diameter (copper wire distance ≤ 20 meters)	mm ²		3*35+2*16	(3*35+2*16)*2	(3*35+2*16)*3	(3*35+2*16)*4	(3*35+2*16)*5	(3*35+2*16)*6	(3*35+2*16)*7
Compressor type	Hermetic scroll								
Compressor qty			2	4	6	8	10	12	14
Power voltage	3N-380V-50HZ								
Starting mode	Starting mode								
Refrigerant	R410A/R22								
Refrigerant charge			13.5*2	13.5*4	13.5*6	13.5*8	13.5*10	13.5*12	13.5*14
Refrigerant control device	Electronic expansion valve(EXV)								
Evaporator	Type		Shell & tube type						
	Water pressure drop	kPa	70						
	Water pipe Dia.DN		65	65*2	65*3	65*4	65*5	65*6	65*7
	Water flow	m ³ /h	24.08	48.16	72.24	96.32	120.40	144.48	168.56
Condenser type	Internally threaded copper tube & hydrophilic aluminum fins								
Protection device	High and low voltage protection, antifreeze protection, temperature control, reverse phase and phase loss protection, high and low voltage protection, high pressure exhaust temperature protection, built-in motor overheat protection, overcurrent protection,check valve, safety valve								
Dimensions	L		2370	2370	2370	2370	2370	2370	2370
	W		1185	2370	3555	4740	5925	7110	8295
	H		2260	2260	2260	2260	2260	2260	2260
Net weight	kg		980	1960	2940	3920	4900	5880	6860
Running weight	kg		1180	2360	3540	4720	5900	7080	8260
Noise	dB(A)		74	74	74	74	74	75	75

Remarks:

- Cooling standard working conditions: ambient temperature 35 °CDB / 24 °C WB; cold water inlet temperature 12 °C, outlet temperature 7 °C.
- Heating standard working conditions: ambient temperature 7 °C DB / 6 °C WB; hot water inlet temperature 40 °C, outlet temperature 45 °C.

5. CONNECTION & BASE

1. Typical wiring & piping connections

Combining RLSFWM series units as basic module (Take RLSFWM204 as an example)

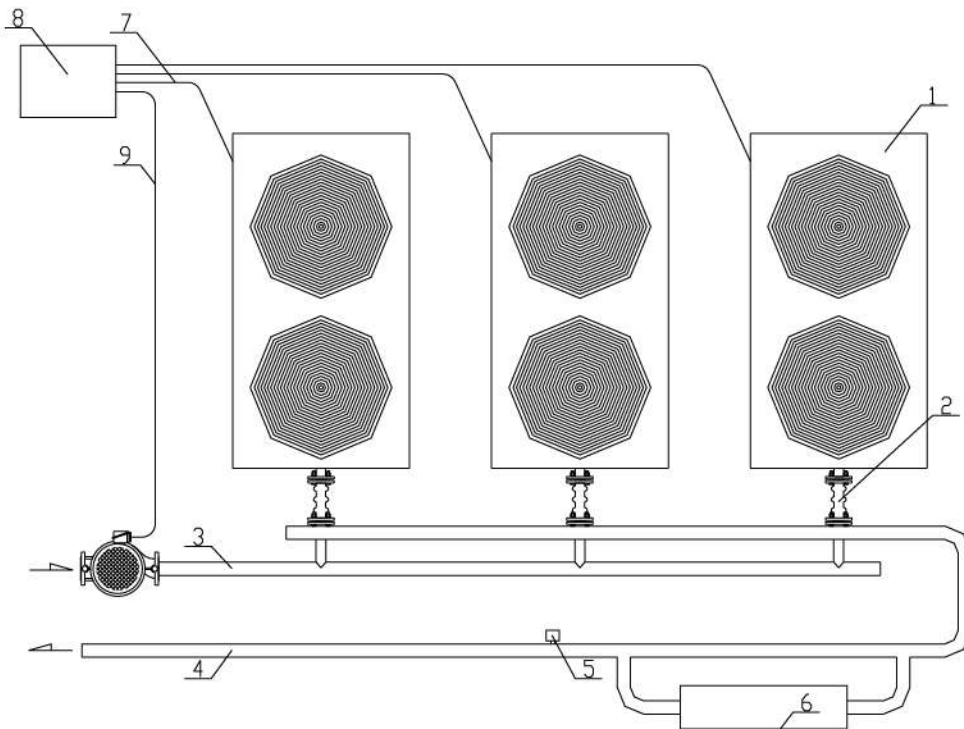

No.	Name	Specification
1	Unit	RLSFWM068R
2	Flexible connection	DN50
3	Inlet water pipe	DN80
4	Outlet water pipe	DN80
5	Water flow switch	LKB-01
6	Auxiliary electric heater	Install as required
7	Unit cable	3 × 10+2 × 6 total 3 groups
8	Distribution box	According to system requirements
9	Water pump cable	According to the pump power

2、RLSFWM68/75 series base position & size

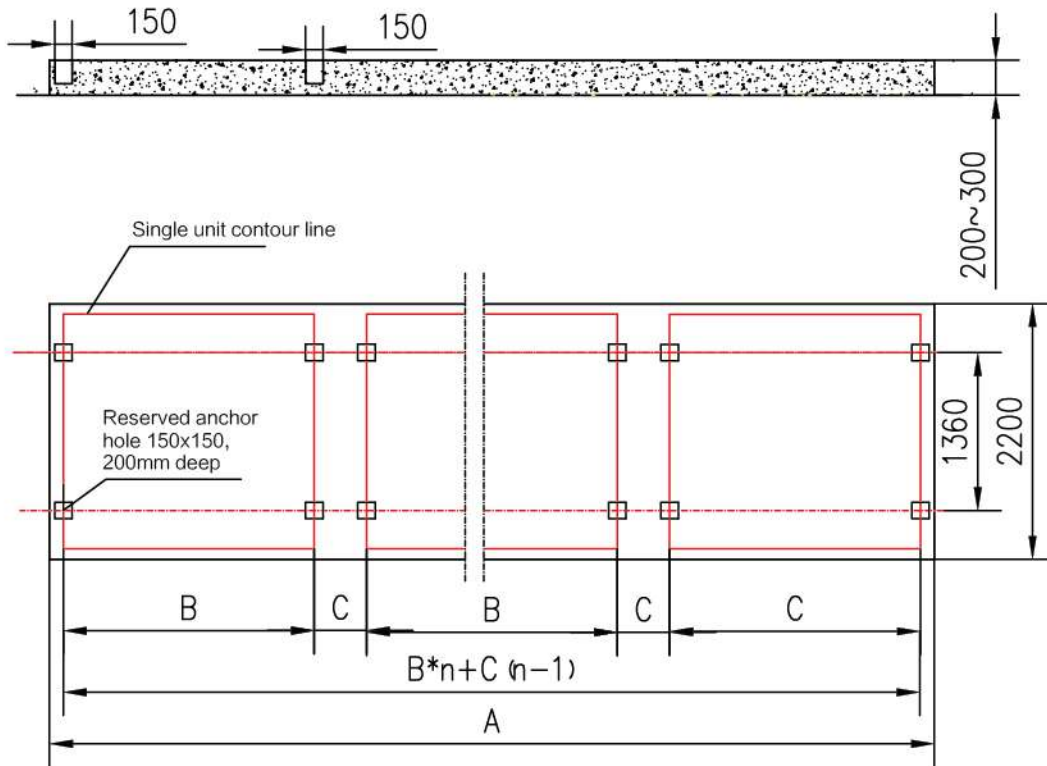

1. The foundation can be either a concrete structure (150–300mm above the ground) or a section steel bracket. The foundation plane should be flat.
2. Add 10–20mm rubber shock cushion between the unit and foundation.
3. The basic design needs to be based on the unit operating weight

RLSFWM68/075 unit base dimensions

	RLSFWM					
	68	136	204	272	340	408
A	1350	2880	4410	5940	7470	9000
B	1030	1030	1030	1030	1030	1030
C	/	600	600	600	600	600
n	1	2	3	4	5	6

3、RLSFWM136 series base position & size

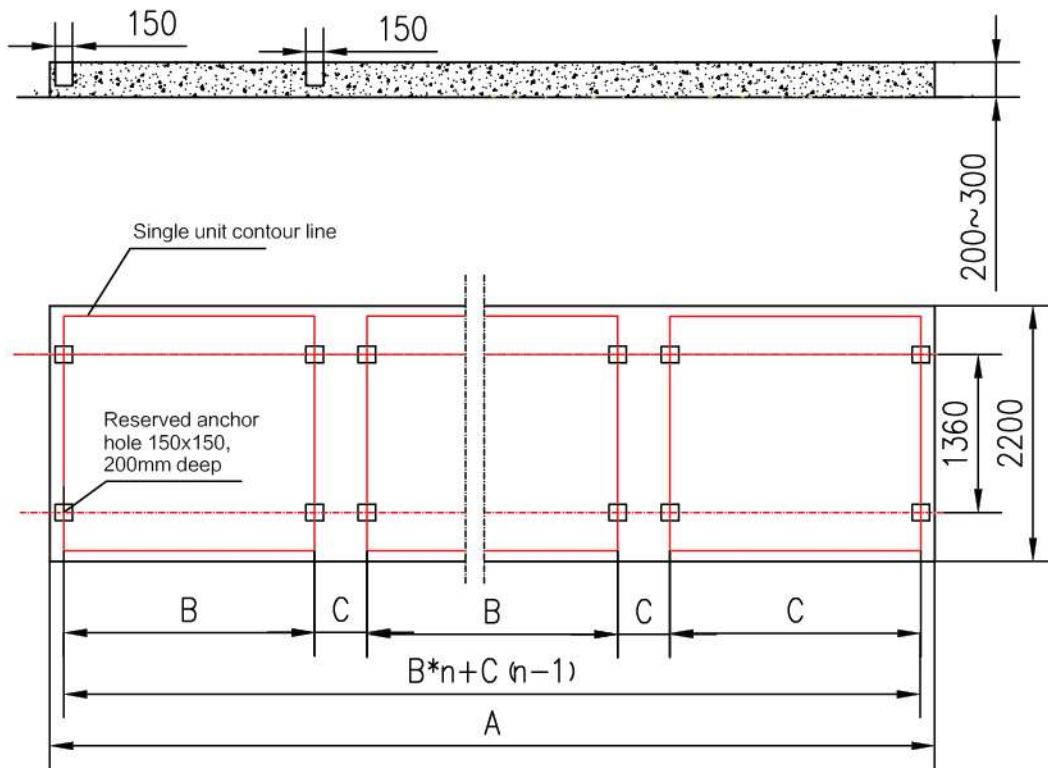

1. The foundation can be either a concrete structure (150–300mm above the ground) or a section steel bracket. The foundation plane should be flat.
2. Add 10–20mm rubber shock cushion between the unit and foundation.
3. The basic design needs to be based on the unit operating weight

RLSFWM136 unit base dimensions

	RLSFWM136						
	136	272	408	544	680	816	950
A	2400	4980	7560	10140	12720	15300	17880
B	2130	2130	2130	2130	2130	2130	2130
C	/	600	600	600	600	600	600
n	1	2	3	4	5	6	7

4、RLSFWM150 series base position & size

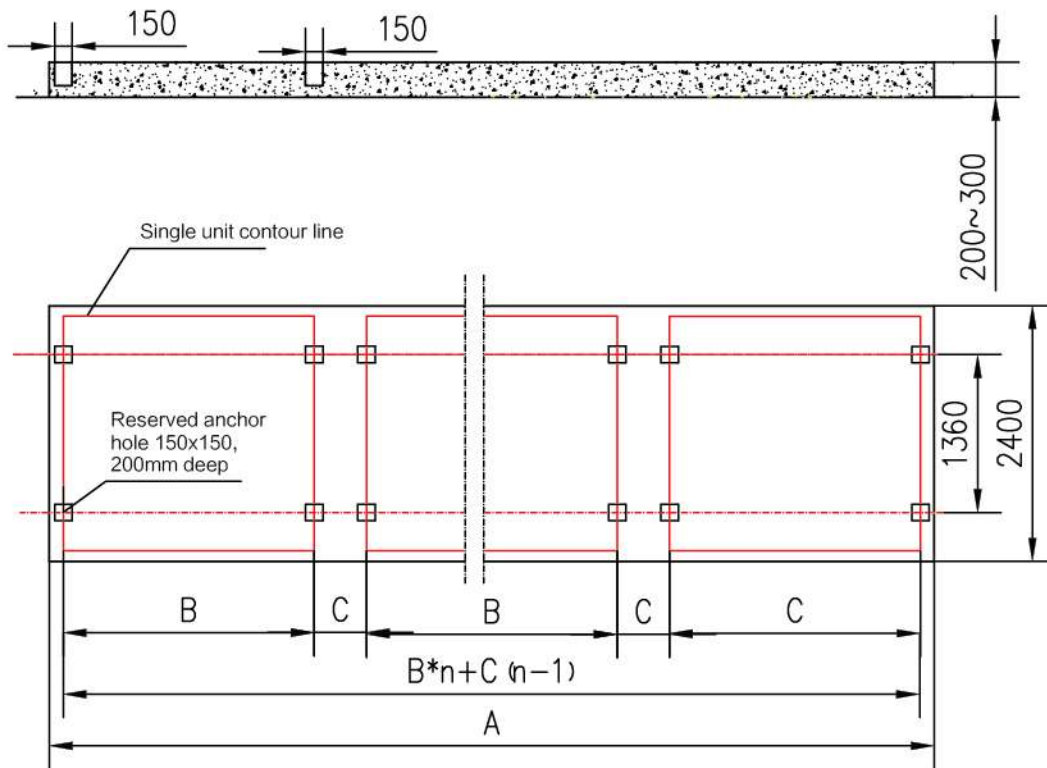

1. The foundation can be either a concrete structure (150–300mm above the ground) or a section steel bracket. The foundation plane should be flat.
2. Add 10–20mm rubber shock cushion between the unit and foundation.
3. The basic design needs to be based on the unit operating weight

RLSFWM150 unit base dimensions

	RLSFWM150						
	150	300	450	600	750	900	1050
A	1485	3120	4755	6390	8025	9660	11295
B	1185	1185	1185	1185	1185	1185	1185
C	/	600	600	600	600	600	600
n	1	2	3	4	5	6	7

5. Installation matters

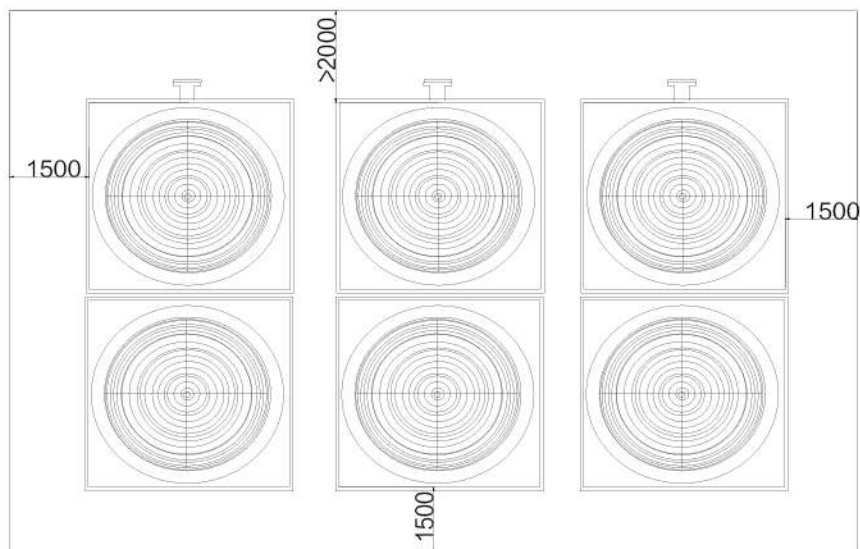

More than 1.5m space should be reserved around the unit to facilitate air circulation and equipment maint

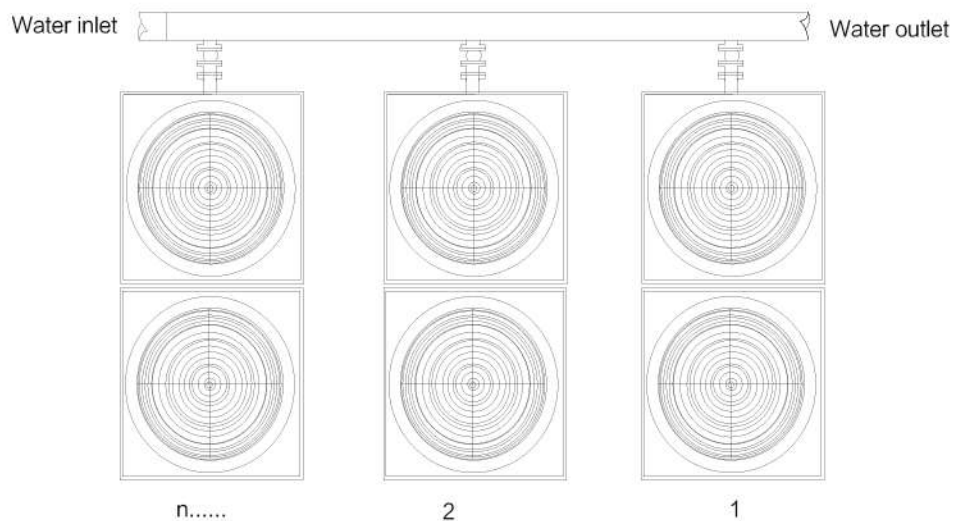

Soft connection should be used between the unit and the pipe.

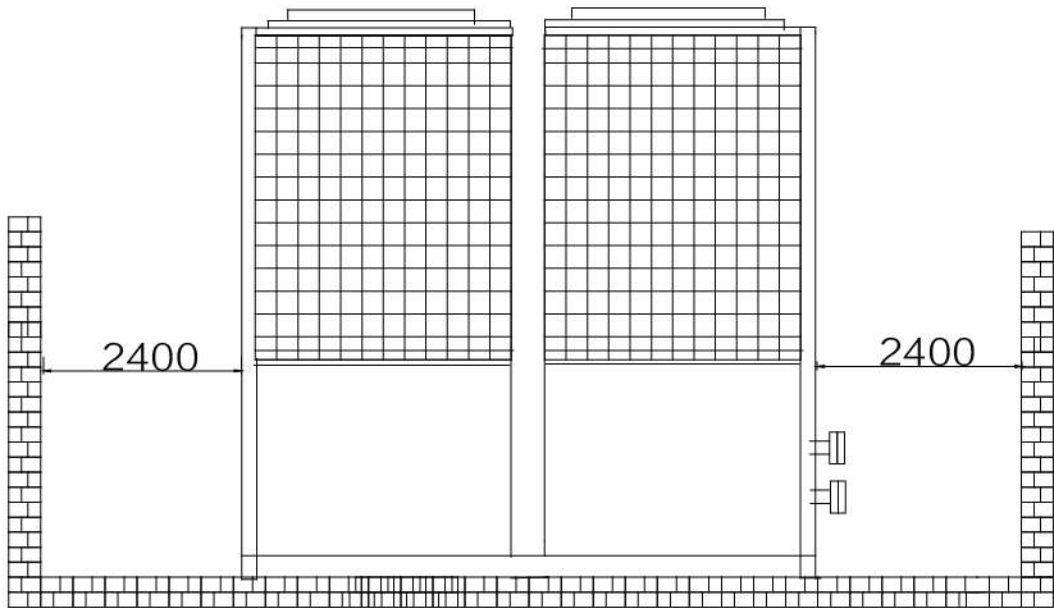

More than 2.0m~2.5m space should be reserved between the unit and the wall to ensure good ventilation.

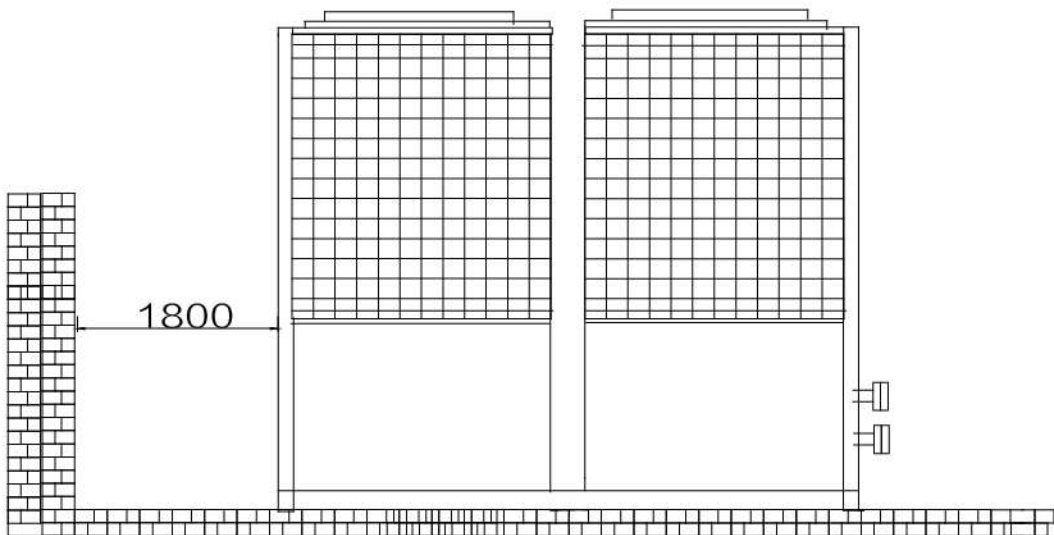

More than 1.5m~2.0m space should be reserved between the unit and the single-sided wall to ensure good ventilation.

6. CORRECTION FACTOR

Correction factor curve of cooling capacity

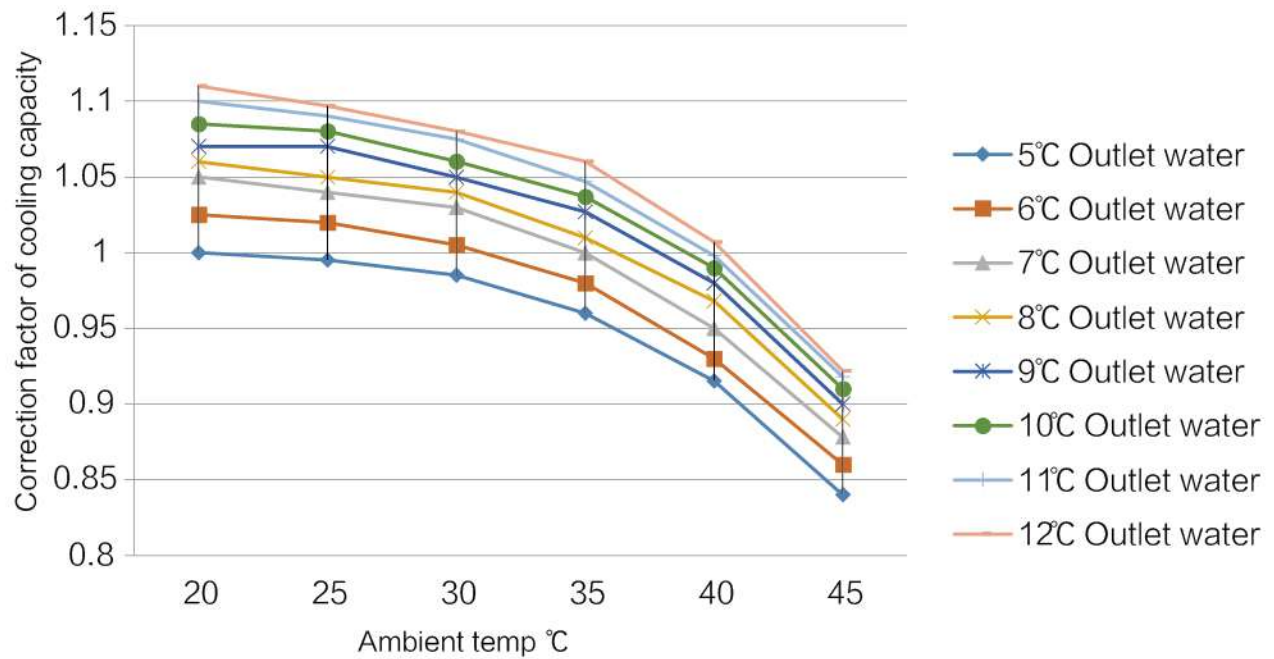

Outlet water temp \ Ambient temp	Ambient temp					
	20	25	30	35	40	45
5°C Outlet water	1	0.995	0.985	0.96	0.915	0.84
6°C Outlet water	1.025	1.02	1.005	0.98	0.93	0.86
7°C Outlet water	1.05	1.04	1.03	1	0.95	0.878
8°C Outlet water	1.06	1.05	1.04	1.01	0.968	0.89
9°C Outlet water	1.07	1.07	1.05	1.027	0.98	0.9
10°C Outlet water	1.085	1.08	1.06	1.037	0.99	0.91
11°C Outlet water	1.1	1.09	1.075	1.047	0.998	0.918
12°C Outlet water	1.11	1.097	1.08	1.06	1.007	0.922

Correction factor curve of input power of cooling

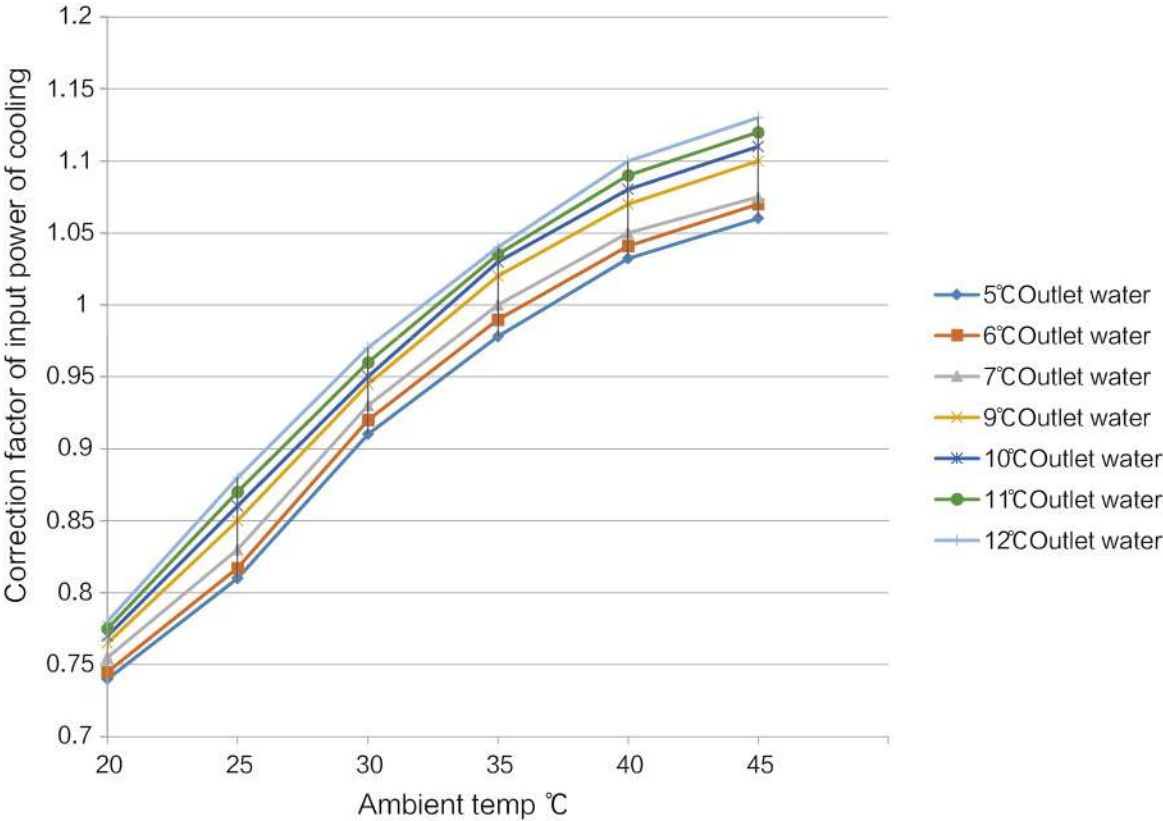

Outlet water temp \ Ambient temp	Ambient temp						
	20	25	30	35	40	45	
5°C Outlet water	0.74	0.81	0.91	0.978	1.032	1.06	
6°C Outlet water	0.745	0.817	0.92	0.99	1.041	1.07	
7°C Outlet water	0.755	0.83	0.93	1	1.05	1.075	
8°C Outlet water	0.76	0.84	0.94	1.01	1.06	1.082	
9°C Outlet water	0.765	0.85	0.945	1.02	1.07	1.1	
10°C Outlet water	0.77	0.86	0.95	1.03	1.08	1.11	
11°C Outlet water	0.775	0.87	0.96	1.035	1.09	1.12	
12°C Outlet water	0.78	0.88	0.97	1.04	1.1	1.13	

Correction factor curve of heating(EVI type)

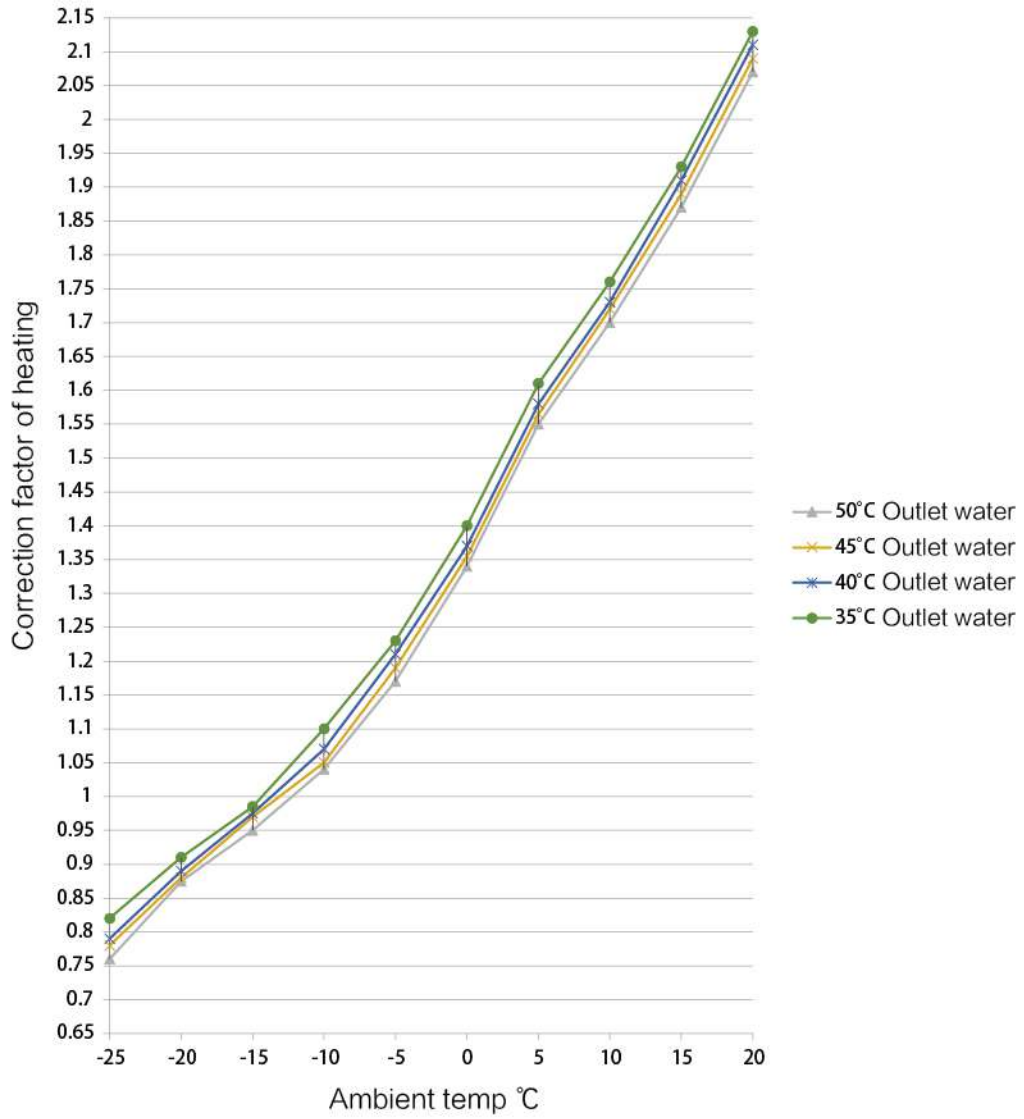

Ambient temp \ Outlet water temp	-25	-20	-15	-10	-5	0	5	10	15	20	25
50°C Outlet water	0.76	0.875	0.95	1.04	1.17	1.34	1.55	1.7	1.87	2.07	
45°C Outlet water	0.78	0.88	0.97	1.05	1.19	1.355	1.565	1.72	1.89	2.09	
40°C Outlet water	0.79	0.89	0.975	1.07	1.21	1.37	1.58	1.73	1.91	2.11	
35°C Outlet water	0.82	0.91	0.985	1.1	1.23	1.4	1.61	1.76	1.93	2.13	

Correction factor curve of input power of heating (EVI type)

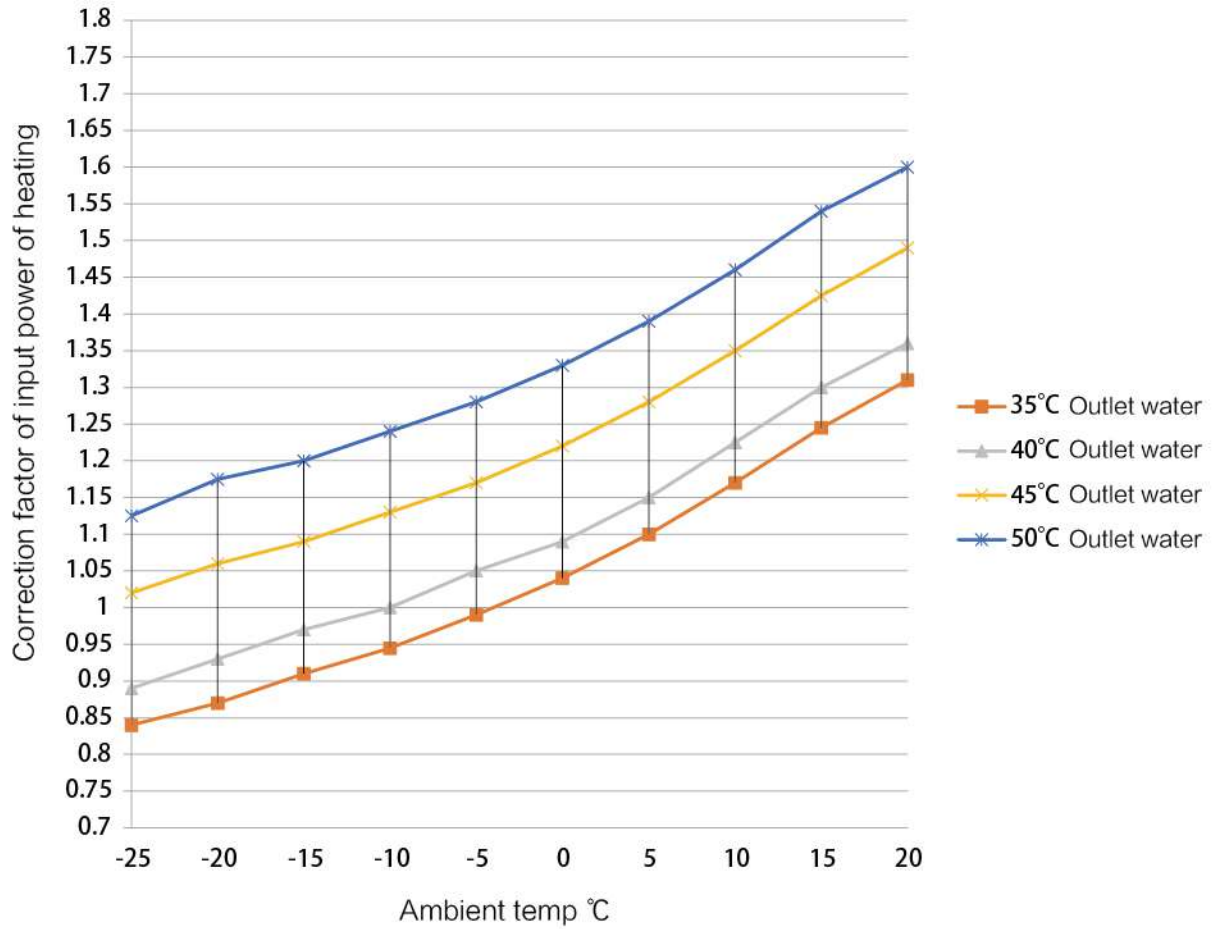

Ambient temp \ Outlet water temp	-25	-20	-15	-10	-5	0	5	10	15	20	25
35°C Outlet water	0.84	0.87	0.91	0.945	0.99	1.04	1.1	1.17	1.245	1.31	
40°C Outlet water	0.89	0.93	0.97	1	1.05	1.09	1.15	1.225	1.3	1.36	
45°C Outlet water	1.02	1.06	1.09	1.13	1.17	1.22	1.28	1.35	1.425	1.49	
50°C Outlet water	1.125	1.175	1.2	1.24	1.28	1.33	1.39	1.46	1.54	1.6	

Correction factor curve of heating

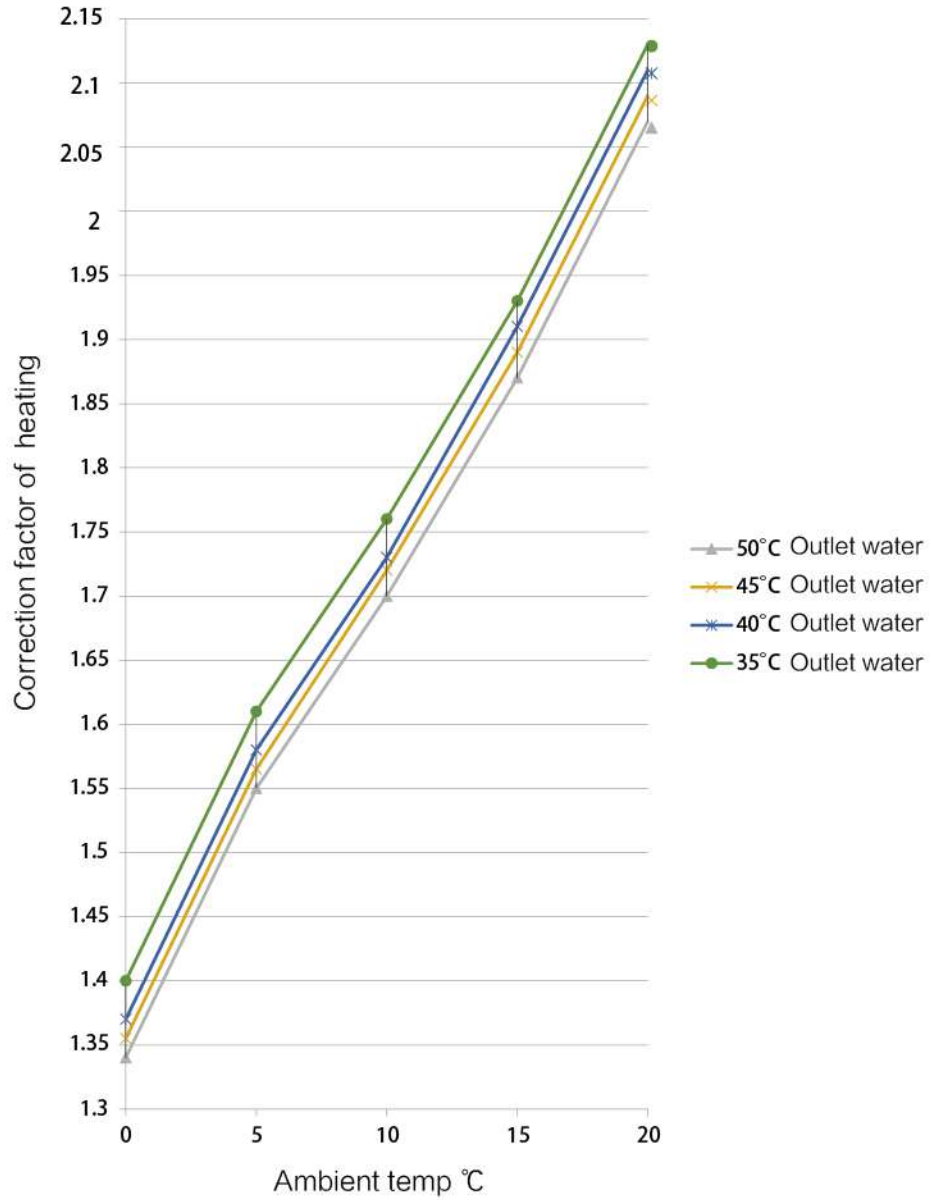

Ambient temp	0	5	10	15	20	25
50°C Outlet water	1.34	1.55	1.7	1.87	2.07	
45°C Outlet water	1.355	1.565	1.72	1.89	2.09	
40°C Outlet water	1.37	1.58	1.73	1.91	2.11	
35°C Outlet water	1.4	1.61	1.76	1.93	2.13	

Input power of correction factor curve of heating

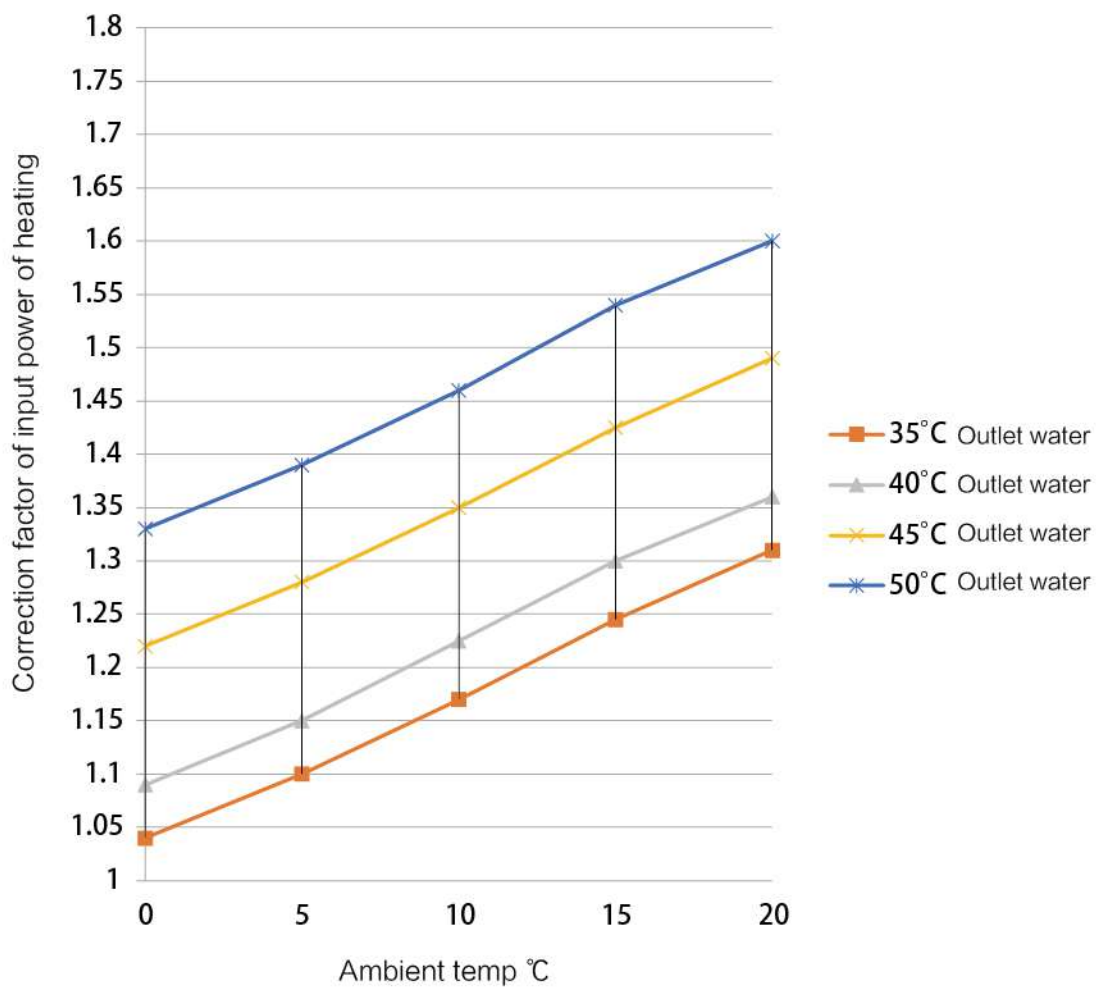

Ambient temp	0	5	10	15	20	25
35°C Outlet water	1.04	1.1	1.17	1.245	1.31	
40°C Outlet water	1.09	1.15	1.225	1.3	1.36	
45°C Outlet water	1.22	1.28	1.35	1.425	1.49	
50°C Outlet water	1.33	1.39	1.46	1.54	1.6	

TESTING CENTER



Testing center covers an area of 6500 square meters; total investment of 50 million RMB, is the largest and most complete detection device in the north of China , the testing range is from household air conditioner to the centrifuge chillers.

Testing center adopt internationally renowned brand measuring instruments, including the United States Agilent data acquisition, Japan Yokogawa power meter, Saibi Ling platinum thermal resistance, to ensure the test accuracy.

Testing center can test multi-unit, air-cooled unit, fan coil unit, ceiling air handling unit, modular air handling unit, purifying air conditioning unit, water loop heat unit, air-cooled module chiller and air-cooled screw chiller.

MAIN PROJECTS



High school building in Brazil



Presidential palace of Kazakhstan



Shanxi Dingxiang County People's Court



Shanxi Yuncheng odd Star Technology Co., Ltd



Beijing Grand Oriental Hotel



Shanxi Linfen High Speed Rail Station



Beijing Sihui building materials city



Shanxi Tongmei Group Zhangze Power Puzhou Power Generation Branch



For more information, please visit our website www.ruidonggroup.com.

Export Office Add: No.129, Yingxiongshan Road, Jinan, Shandong, China

Factory Add: No.6555 Tianqu East Road, Economic Development Zone, Dezhou, Shandong, China

Tel: 0086-531-83199577 Mobile: 0086-15505347651 Mail: sales@ruidonggroup.com

Version number: 2021.04

The contents will be changed due to product updates without prior notice, please refer to the actual product.

This document has been proofread many times, but there may still be errors or omissions, please understand.